



ZEEKR

Zeekr 7x
Type: 5dr SUV
(2025 -)



ZEEKR
7X Australia

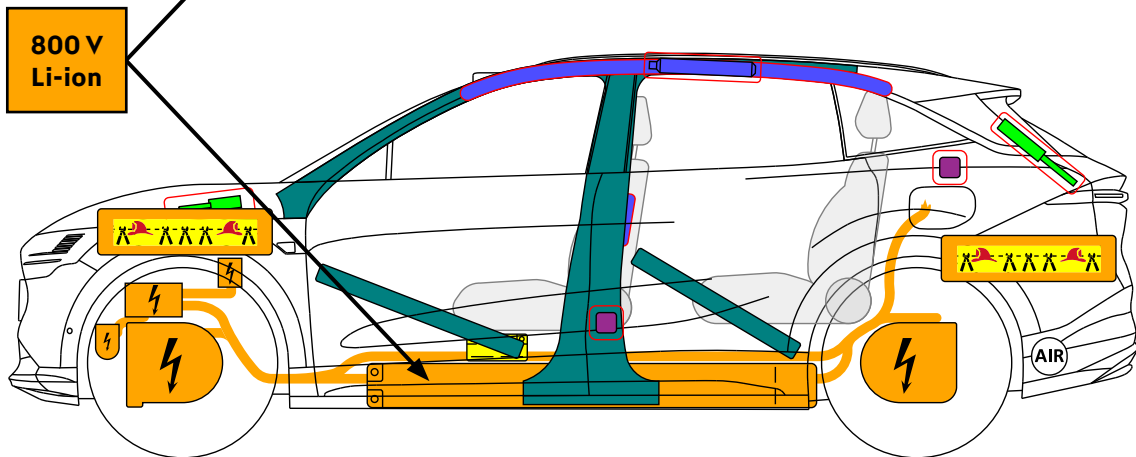
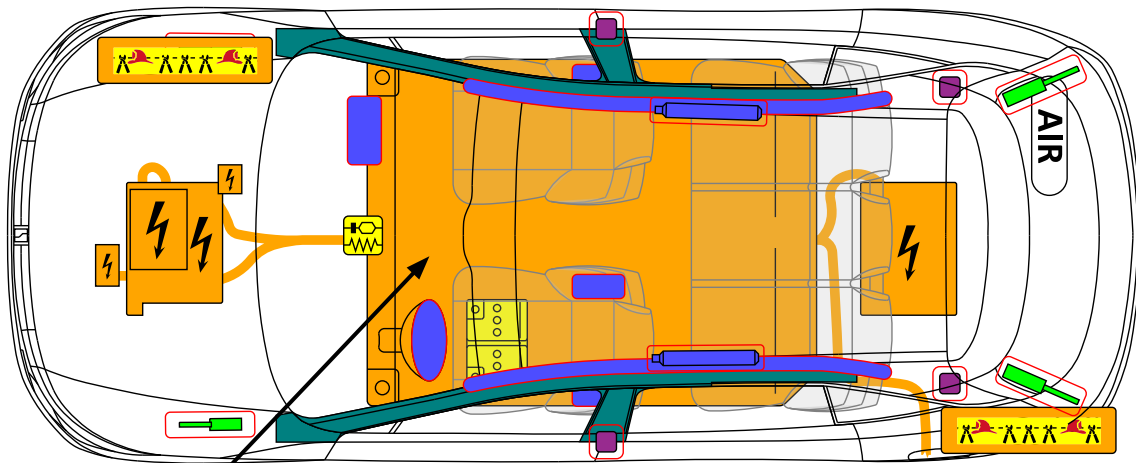

800 V
Li-ion

- Airbag
- Stored gas inflator
- Seat belt pretensioner
- SRS control unit
- Battery low voltage
- Gas strut / Preloaded spring
- Cable cut
- High voltage component
- Battery pack, high-voltage
- High voltage power cable
- AIR Air tank
- High strength zone

Internal reference

Version

Creation date

Page

Zeekr_7X_SUV_2025_5d_Electric_EN

01

01/2025

1 / 4



ZEEKR

Zeekr 7x
Type: 5dr SUV
(2025 -)



ZEEKR
7X Australia

1. Identification / recognition



LACK OF ENGINE NOISE DOES NOT MEAN VEHICLE IS OFF. SILENT MOVEMENT OR INSTANT RESTART CAPABILITY EXISTS UNTIL VEHICLE IS SHUT DOWN. WEAR APPROPRIATE PPE.

Brand logo



Model name



Charge port



2. Immobilisation / stabilisation / lifting

Immobilise vehicle:

1. Block wheels and set parking brake
2. Push the P (park) button to select the P (park) position

Lifting points:

- Appropriate lifting points
- High voltage battery

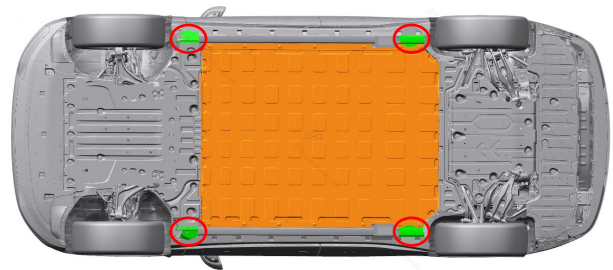

3. Disable direct hazards / safety regulations

The propulsion system is disabled when the 'Safety mode See Manual' indicator in the instrument cluster is illuminated.

Main method:

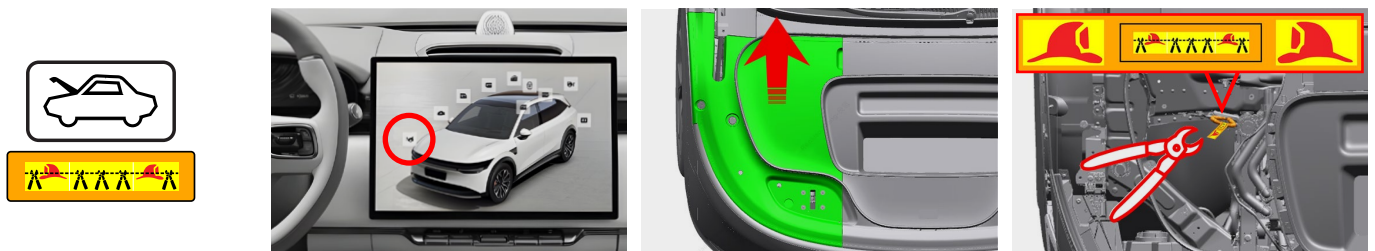

Alternative method:



Internal reference	Version	Creation date	Page
Zeekr_7X_SUV_2025_5d_Electric_EN	01	01/2025	2 / 4



ZEEKR

Zeekr 7x
Type: 5dr SUV
(2025 -)



ZEEKR
7X Australia

Disconnect 12 Volt battery

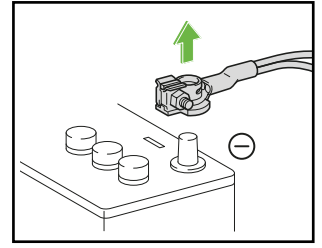
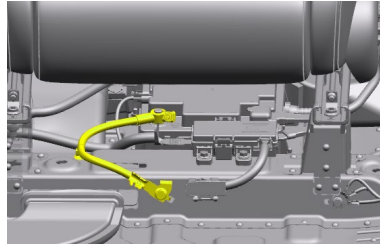
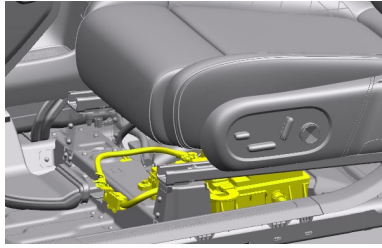
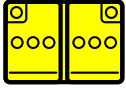

Safety instructions

Always assume the vehicle is powered, even if it is silent!

Make sure that the vehicle is immobilized and the propulsion system is deactivated; Never touch, cut, or open any orange high voltage power cable or high voltage component; In case of a collision with seat belt pretensioner activation / airbag deployment, the high voltage system will be disabled automatically. The restraint systems are still active. Wear appropriate PPE.

4. Access to the occupants

Steering wheel, tilt control

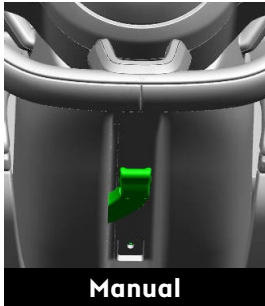

Manual

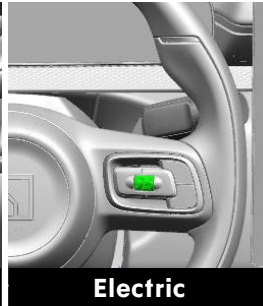

Electric

Seat adjustment

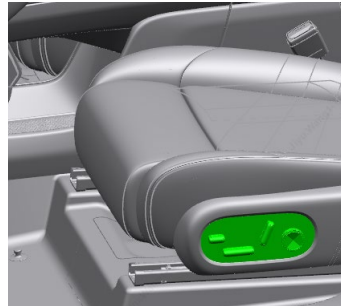

Glass types

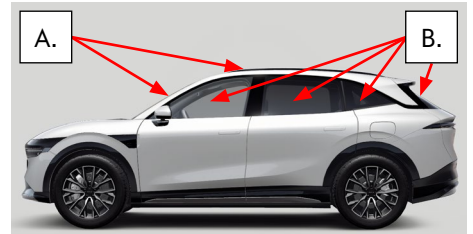

- A. Laminated glass
- B. Tempered glass

Opening side doors from outside with power

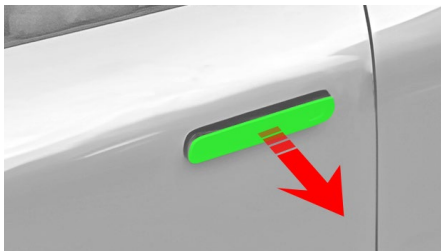

Opening side doors from inside with power

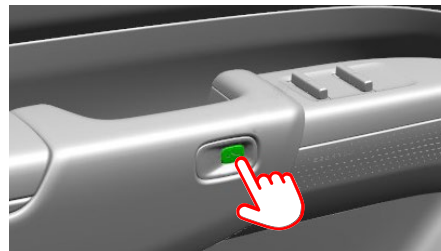

Opening side doors from inside without power

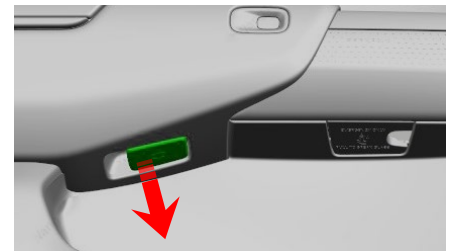

5. Stored energy / liquids / gases / solids

	800V	
	12V	
	HFC-1234yf 875 +/- 25 g	
	17 bar	



When conventional coolant leaks (check reservoir) from the high voltage (HV) battery cooling system, HV-battery can become unstable with risk of thermal runaway. An increasing HV-battery temperature might be an indicator of thermal runaway. Wear appropriate PPE.

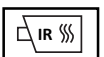

Internal reference

Version

Creation date

Page

Zeekr_7X_SUV_2025_5d_Electric_EN

01

01/2025

3 / 4



ZEEKR

Zeekr 7x
Type: 5dr SUV
(2025 -)



ZEEKR
7X Australia

6. In case of fire

Extinguishing method for the high voltage (HV) battery:



LARGE AMOUNTS OF PURE WATER



POTENTIAL RISK OF HV-BATTERY FIRE RE-IGNITION / DELAYED FIRE! WEAR APPROPRIATE PPE.



7. In case of submersion

- There is no increased risk of electric shock in water resulting from the high voltage system
- If possible, remove the vehicle from the water and continue with the deactivation procedure for this vehicle (see chapter 3)

8. Towing / transportation / storage

Recovery hook storage

Location front hook

Location rear hook

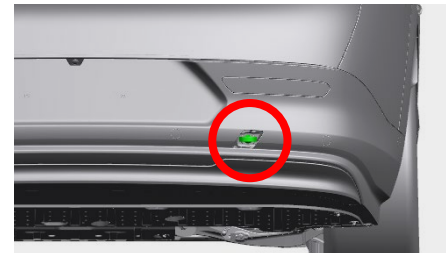
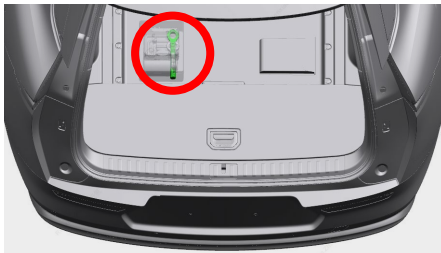

Towing

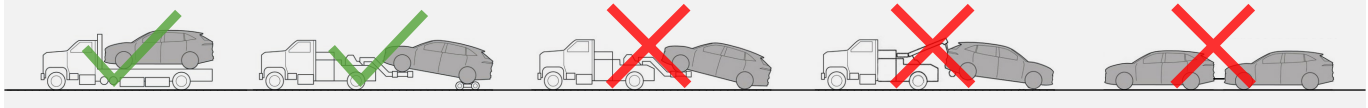

STORE VEHICLE IN AN OPEN-AIR PARKING AT A SAFE DISTANCE $\geq 5M$ FROM OTHER OBJECTS OR VEHICLES!

POTENTIAL RISK OF HV-BATTERY FIRE RE-IGNITION / DELAYED FIRE! WEAR APPROPRIATE PPE.

10. Explanation of pictograms used

	Electric Vehicle		Flammable
	Warning, Electricity		Hazardous to the human health
	General warning sign		Acute toxicity
	Warning: low temperature		Corrosives
	Air-conditioning component		Explosive
	Use water to extinguish the fire		Bonnet
	Use thermal Infrared camera		Boot

Internal reference

Version

Creation date

Page

Zeekr_7X_SUV_2025_5d_Electric_EN

01

01/2025

4 / 4